

Unity entrance lock

Fitting instructions

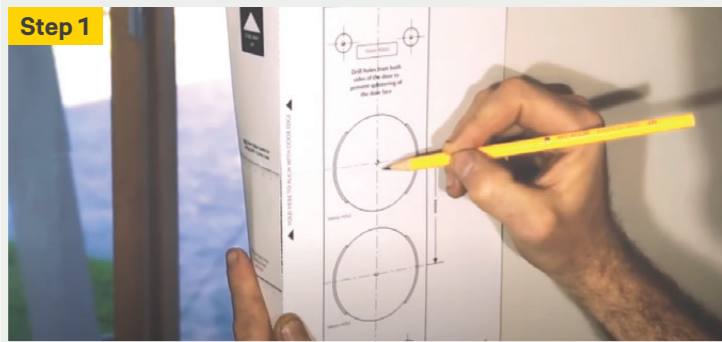

Step 1
Using the door template provided, mark out the required holes for drilling including the latch and Door Position Sensor (DPS) hole. Then drill holes with appropriate tools.



Step 2
To prepare the lock for install, you will need to establish whether the door is right or left hand opening according to the image above. Once identified, you can now select the correct handing of the lock to suit the door entry, right or left.



Step 3
To hand the lock, hold down on the metal slide tab and rotate the handle left or right depending on your selected handing. Ensure you hold down the tab at all times during the rotation. Rotation should be smooth, if you experience firm resistance, release the handle and slide tab and repeat handing process. Ensure you complete this for both handles.



Step 4
Insert the DPS through the 12.5mm hole on the door edge. Feed the cable first through the DPS hole.

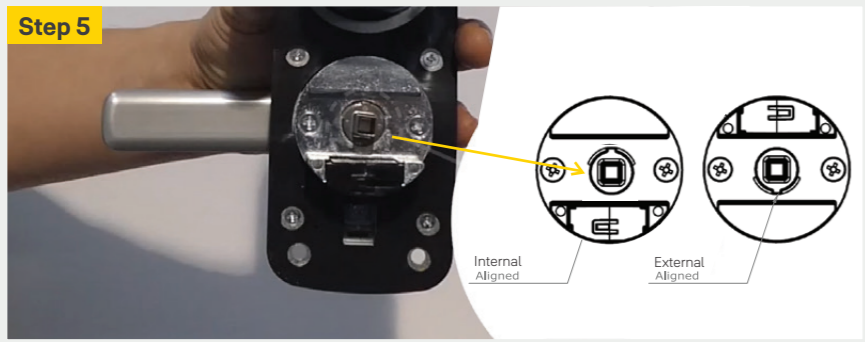

Step 5
Prior to fitting the lock to the door, ensure that the clutch is straight and aligned on the internal and external furniture. *Door thicknesses over 45mm will need to use the spindle extensions. Establish the thickness of your door and select the required fixing screws and spindles (if required). Feed the spindle extension shaft over the spindle extension and then feed this through the latch.

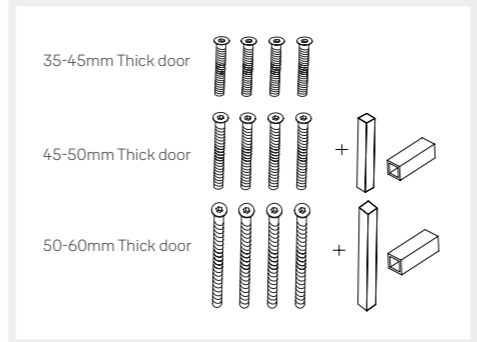

Step 6
Remove the battery cover using the release tab located at the bottom of the internal furniture. Place the battery cover aside for the time being.

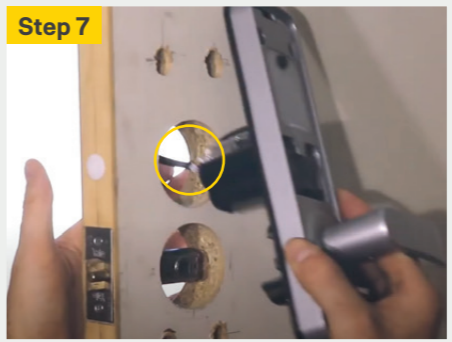

Step 7
To fit the internal furniture to the door, feed the main cable and the DPS cable through the top hole and then fit the lock into place. Connect the DPS from the internal furniture to the DPS cable fit previously through the door.



Step 8
Taking the external furniture, connect the main cable from the internal furniture into the power housing found at the top of the external furniture - A.

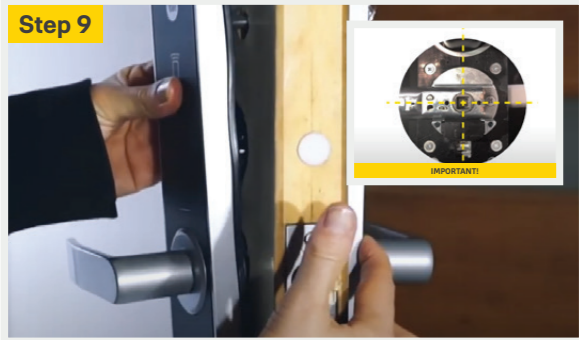

Step 9
Taking care not to pinch the cables, fit the external furniture to the door. Ensure the spindle is aligned and sits in the latch when installing both the internal and external furniture to the door. For doors without a spindle (<45mm), ensure that the clutch spindle is fitted into the latch as shown.



Step 10
Using a Phillips screwdriver and selected mounting screws, fix the two handles together. It is now time to install the batteries in the lock. **IMPORTANT: Do not close your door prior to installing the batteries or you could be locked out.**

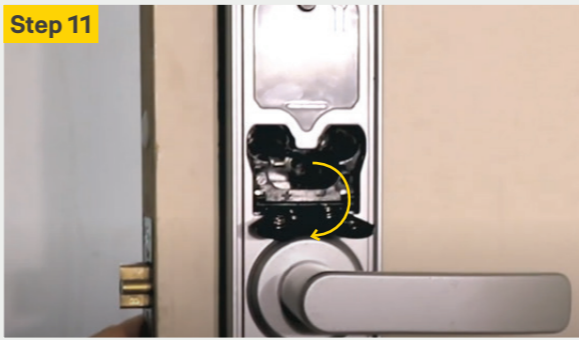

Step 11
Push in and slide down on the battery tab as shown in the image to open the battery compartment. Install the 4 x AA Alkaline batteries. *Carefully note the indicated "+" & "-" pattern shown on battery compartment. Once the batteries are installed, test the latch retracts when turning both internal and external levers.

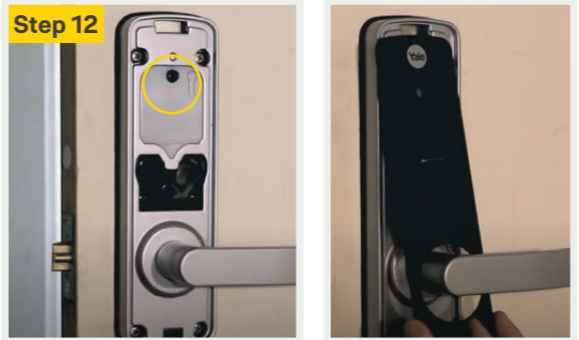

Step 12
If not, press the internal button to switch between lock and unlock mode then try again. To complete the installation, replace the battery cover top end first and push in and up to lock into place. Your lock will turn on, ready to connect to your phone.

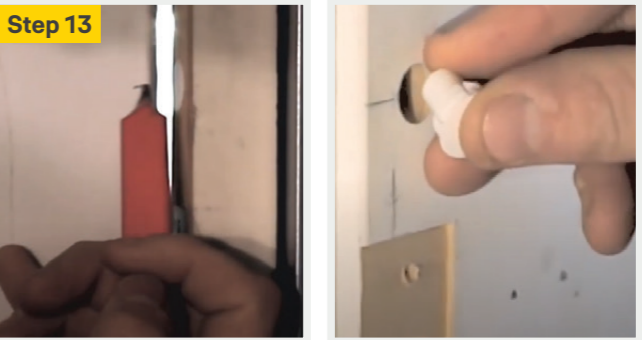

Step 13
Align the DPS location onto the door jamb using a pencil. Drill a 12.5mm diameter x 15mm deep hole. Fit the DPS magnet into the door jamb. Mark the position of the latch bolt to determine the striker height. Fix the strike box to the jamb and then secure the strike plate over with the timber fixing screws. For lock setup, please refer to the Yale Access Quickstart Guide.